

VIEW INSTALLATION VIDEO AT [www.worksconnection.com/prolaunch/](http://www.worksconnection.com/prolaunch/)

### 12-338 PRO LAUNCH INSTALLATION INSTRUCTIONS

We at Works Connection Inc. appreciate your purchase of the Pro Launch for your motorcycle. **If you have any problems or questions, please email us at [info@worksconnection.com](mailto:info@worksconnection.com)**

Whenever you see symbols, heed their instructions! Always follow safe operating and maintenance practices.

**⚠ WARNING**

**WARNING** indicates a hazardous situation which, if not avoided, could result in death or serious injury.

**⚠ CAUTION**

**CAUTION** indicates a hazardous situation which, if not avoided, could result in minor or moderate injury.

**⚠ WARNING**

Installing these parts improperly can cause a crash, serious injury or death.

**Before you start:**

Read these instructions and those in the OEM Service Manual for removing and installing fork tubes, as applicable. **If you are not sure that you can follow the instructions, have these installed by a professional mechanic.** Refer to the OEM Service Manual for proper torque values.

Keep all of your OEM parts, as some parts they will be utilized in conjunction with the installation of your Pro Launch.

**⚠ CAUTION**

The Pro Launch kit is designed for use with your OEM plastic fork guards.

**TOOLS & SUPPLIES REQUIRED: (not supplied)**

- Torque wrench
- Common Hand Tools (including Scissors, 3/16" drill, 5/16" drill, 4mm Allen wrench, Phillips screw driver)
- Hand Drill
- Loctite#242 (Blue)

**⚠ CAUTION**

Before you begin working, be sure you are wearing eye protection and gloves.

## INSTALLATION AND ASSEMBLY OF PRO LAUNCH

### **WARNING**

**Do not attempt to install fork ring without first removing right side fork tube from bike.**

1. Remove the front wheel and the right side fork assembly in accordance with Service Manual. Remove Allen bolt from fork ring and slide the fork ring down fork tube. **See Figure 1.**

### **CAUTION**

You will have to spread fork ring to get it past the widest spot (lower triple clamp area) on the fork tube.

Slide the fork ring down into position as shown in photo. Start the Allen bolt but leave loose for now.

2. Determining the correct preload position. You have 3 typical options:

- a. 90mm-Taller riders/Loose dirt conditions.
- b. 100mm-Best all-around choice.
- c. 110mm-Shorter riders/tacky conditions.

Cut out the paper fork guard template (cut relief darts if indicated) with scissors. Remove the right side fork guard from the fork assembly and tape the template to the fork guard making sure that the profile of the template fits the fork guard accurately. **IF TEMPLATE IS NOT FIT TO THE FORK GUARD ACCURATELY FORK RING COULD IMPACT AIR CANISTER ON LOWER FORK LUG.** Use a minimum of six 1" pieces of 3/4" masking tape to secure the template and prevent it from moving. This is very **critical** to assure the correct alignment for placement of the trigger mechanism later on in the installation process. **See Figure 2.**

3. Take the aluminum drill guide supplied in the kit and match it to the drawing of its outline on the paper template. Secure the drill guide to the paper template with masking tape.  
Note: Tape the entire perimeter of the drill guide. **See Figure 3.**

4. Using your 3/16" drill bit: pass it through the drill guide and drill through the fork guard for both 3/16" holes. **See Figure 4.**

5. Push the two Phillips head trigger mechanism mount screws through the drill guide and into the fork guard. The screws will act as aligning dowels for the next two steps. **See Figure 5.**

6. Use the 3/4" countersink to bore the center hole in the fork guard. The drill guide will help maintain accuracy as the countersink bores through the fork guard.  
NOTE: The 3/4" hole is the primary support for the trigger mechanism. **See Figure 6.**

7. Drill the 5/16" hole. Remove the drill guide and paper template. Clean up any flashing after you're done. **See Figure 7.**

### **CAUTION**

This step should be done by hand only. **DO NOT USE POWER TOOLS OR DRILLS IN THIS STEP**

8. Use the countersink to bevel the two trigger mechanism mount holes on the inside (backside) of the fork guard. **See Figure 8.**

NOTE: The plastic cuts quickly and the use of a power drill could easily cut too large a hole or even bore through the fork guard making it useless. You will want to countersink the plastic enough so the backing washers fit down into the countersunk recesses. You may have to 'lean' the countersink towards the top and bottom of the fork guard and carve out plastic in order to get a round (not oblong) countersunk area.

9. NOTE: *If you have graphics on your fork guard: Trim away graphic material from the 3/4" hole. Hold trigger mechanism on fork guard and trace outline of trigger mechanism with a pencil. Trim and remove graphic material so trigger mechanism sits directly on fork guard.* Install the trigger mechanism onto the fork guard using the backing washers and Phillips head screws. Use #242 Loctite on both screws. Make sure that you have a good fitting Phillips screwdriver, so as to ensure the screws fully seat the backing washers into their countersunk recesses.  
**See Figure 9.**

## REASSEMBLY ORDER

1. Reinstall fork assembly in accordance with Service Manual. Ensure all fasteners are properly torqued.  
**TORQUE:** See OEM Service Manual for torque specification.
2. Install the fork guard with your Pro Launch.
3. Reinstall your front wheel in accordance with Service Manual. Ensure all fasteners are properly torqued.  
**TORQUE:** See OEM Service Manual for torque specification
4. The final step is to properly align the fork ring and trigger mechanism. This may be easily accomplished by putting your bike in the back of a truck or trailer so you can pull the front end down with tie-downs. Pull down just far enough so the trigger mechanism is just above the fork ring. Sight down from the top of the fork tube and **adjust the fork ring so that it will not impact air canister** on lower fork lug and that it is in vertical alignment with the trigger mechanism. Torque the Allen bolt to secure fork ring. **See Figure 10.**  
**TORQUE: 6 ft. lb. maximum.**

We have found that the easiest way to set the Pro Launch by yourself is to stand on the left side (shifter side) of the bike and perform the following: Place your left hand on the trigger. Next, roll the bike forward and quickly apply the front brake which will cause the forks to dive down and the fork ring to travel below the trigger assembly. Finally, time it so that you pull up on the trigger once the fork ring has traveled below the trigger assembly and you're all set. The trigger will release itself from the fork ring automatically when the front brake is applied and/or the front end dives. Periodically check the mechanism for smooth operation and alignment with the fork ring. **See Figure 11.**

Congratulations. You have now completed the installation of your Pro Launch for your motorcycle.

### CAUTION

#### **After your first ride:**

Inspect your Pro Launch, front fork and fork guard. Check the torque on all the fasteners of your steering system.

**Regular checks and maintenance:** Periodically check all the nuts and bolts to ensure that they are properly fastened and torqued, especially after adjustments. General Maintenance intervals are specified in your OEM Service Manual. If adjustment is needed, follow the guidelines in your OEM Service Manual.

#### **In the event of a crash:**

1. Remove and inspect the Pro Launch. Look for damage, deformation or looseness.
2. Inspect your forks for any sign of damage or damaged parts.

### WARNING

Operating the motorcycle with damaged parts can cause a crash, serious injury or death. **If you aren't sure whether your Pro Launch is damaged, return it to Works Connection for inspection and evaluation.**

### CAUTION

**AFTER EVERY RIDE-Flush the inside of the fork guard/trigger mechanism to clear any debris. Periodic cleaning the trigger mechanism recommended-** Remove the fork guard and the trigger assembly. Disassemble the trigger mechanism by carefully driving out the roll pin securing the trigger itself. Remove any debris from the trigger and the trigger body. Reinstall the roll pin. Install the trigger assembly on fork guard and fork guard back on bike.

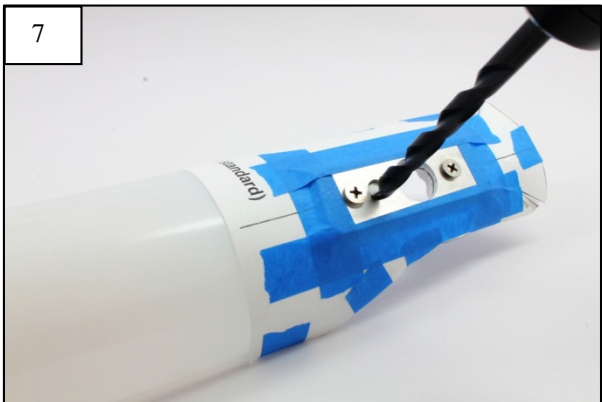
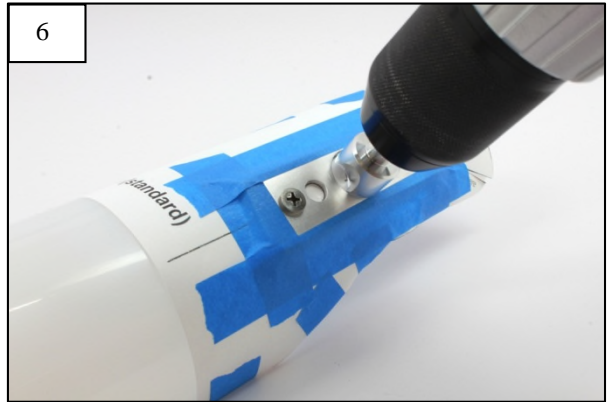
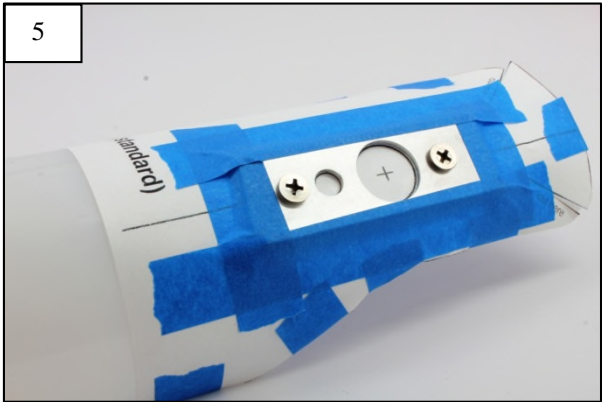
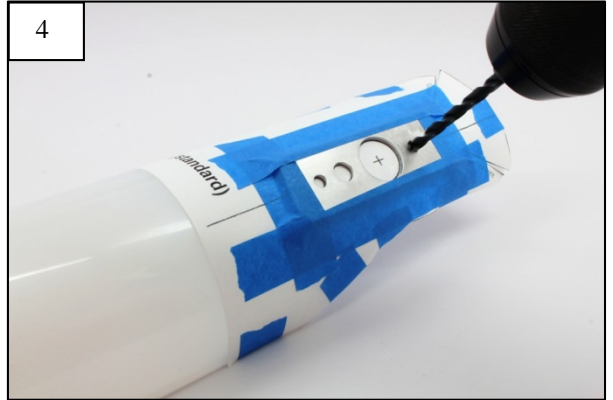
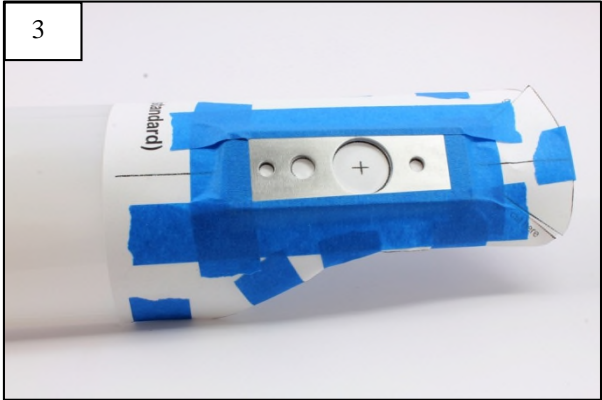
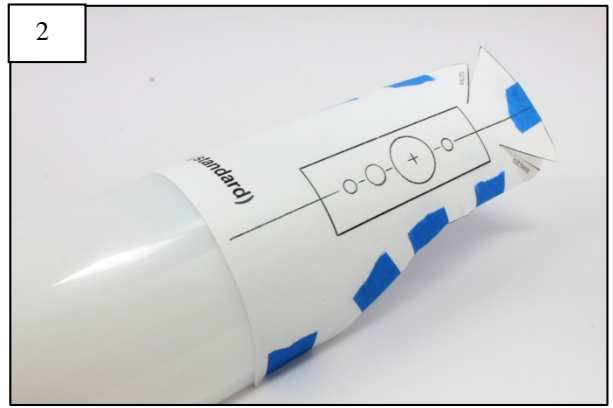



Part # 12-338

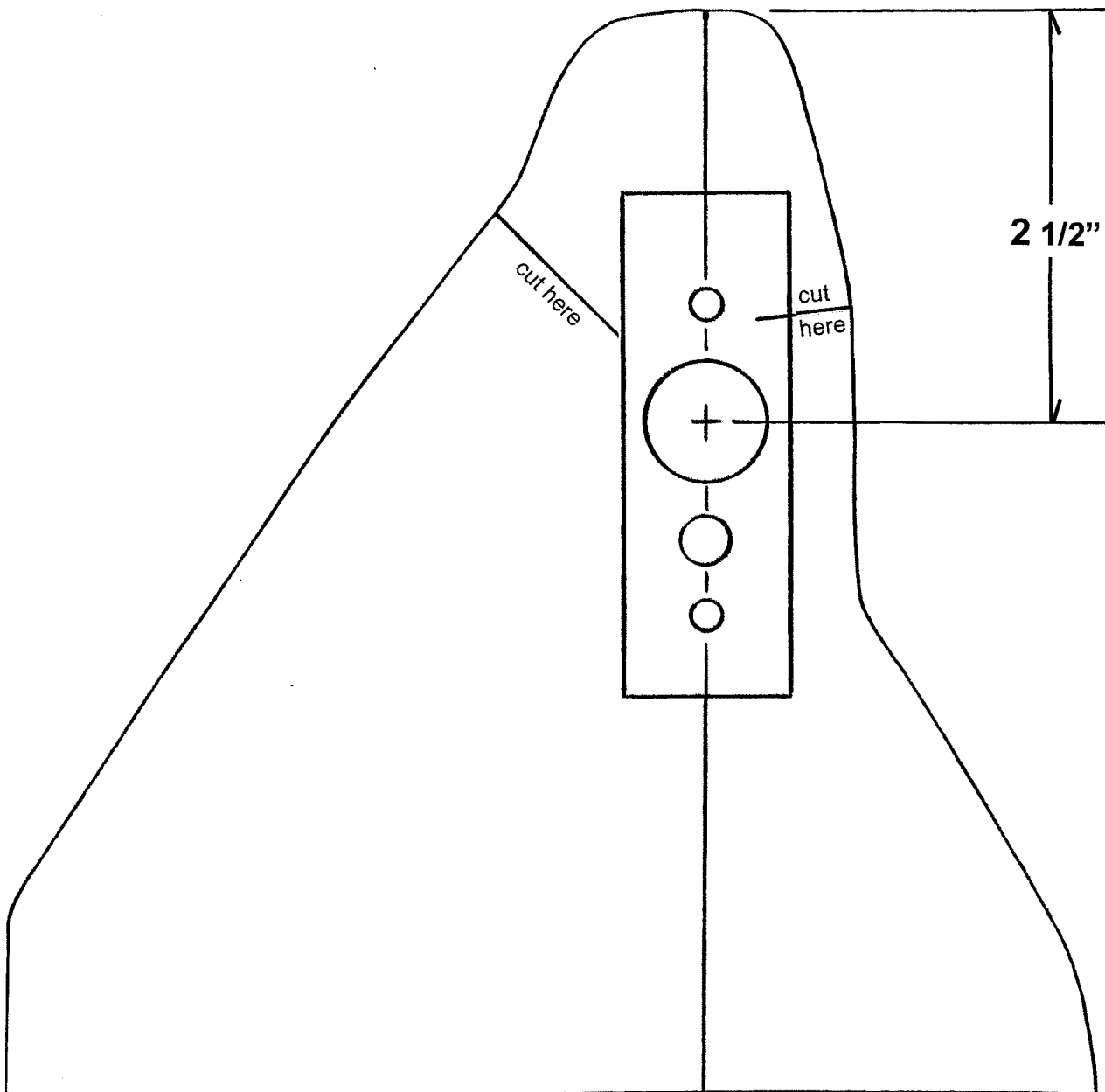

**90mm-Taller riders/deep rut starts/concrete**  
**100mm- (SHOWN) Best all-around choice**  
**110mm-Shorter riders/tacky conditions**